



RDF301

RDF301.50

Semi flush-mount room thermostats with KNX communications

RDF301
RDF301.50

For 2-pipe, 2-pipe with electrical heater, and 4-pipe fan coil units
For use with compressors in DX type equipment

- **KNX bus communications (S-mode and LTE mode)**
- **Backlit display**
- **2P / PI / P control**
- **Outputs for on/off or 3-position control**
- **Outputs for 3-speed or 1-speed fan**
- **2 multifunctional inputs for keycard contact, external sensor, etc.**
- **Operating modes: Comfort, Economy and Protection**
- **Automatic or manual fan speed control**
- **Automatic or manual heating/cooling changeover**
- **Minimum and maximum limitation of room temperature setpoint**
- **Control depending on the room or the return air temperature**
- **Adjustable commissioning and control parameters**
- **Commissioning with Synco ACS700, ETS3 Professional or via local HMI**
- **Integration into Synco**
- **Integration into DESIGO and Apogee via group addressing (ETS3) or via individual addressing**
- **Integration into third-party system via group addressing (ETS3)**
- **Mounting on recessed rectangular conduit box, 60.3 mm fixing centers**
- **AC 230 V operating voltage**

Additional RDF301.50 features:

- **Four buttons to control KNX actuators via KNX S-mode (functions: switching, dimming, blinds control, 8-bit scene)**

Room temperature control (heating or cooling) in individual rooms and zones by means of:

- 2-pipe fan coil units
- 2-pipe fan coil units with electrical heater
- 4-pipe fan coil units
- Compressors in DX-type equipment
- Compressors in DX-type equipment with electrical heater

The RDF301.. controls:

- One single or 3-speed fan
- One or two on/off valve actuators
- One on/off valve actuator and one 1-stage electrical heater
- One 3-position valve actuator
- One 1-stage compressor in DX-type equipment, or one 1-stage compressor with electrical heater

Used in systems with:

- Heating or cooling mode
- Automatic heating/cooling changeover
- Manual heating/cooling changeover
- Heating and cooling mode (e.g. 4-pipe system)

The room thermostats are delivered with a fixed set of applications.

The relevant application is selected and activated during commissioning using one of the following tools:

- Synco ACS
- ETS3 Professional (planned)
- Local DIP switch and HMI

Functions

- Maintain room temperature via built-in temperature sensor or external room temperature / return air temperature sensor
- Changeover between heating and cooling mode (automatic via local sensor or bus, or manual)
- Select application via DIP switches or commissioning tool (ACS700, ETS3 Professional)
- Select operating mode via operating mode button on the thermostat
- Temporary Comfort mode extension
- Single speed or 3-speed fan control (automatic or manual)
- Display current room temperature or setpoint in °C and/or °F
- Minimum and maximum limitation of room temperature setpoint
- Button lock (automatic and manual)
- Two multifunctional inputs, freely selectable for:
 - Operating mode switchover contact (keycard)
 - Automatic heating/cooling changeover sensor
 - External room temperature sensor or return air temperature sensor
 - Dewpoint sensor
 - Electrical heater enable
 - Fault input
 - Monitor input for temperature sensor or switch status

- Advanced fan control function, e.g. fan kick, fan start, selectable fan operation (enable, disable or depending on heating or cooling mode)
- Purge function together with 2-port valve in a 2-pipe changeover system
- Reminder to clean filters
- Floor heating temperature limit
- Reload factory settings for commissioning and control parameters
- KNX bus (terminals CE+ and CE-) for communication with Synco or KNX compatible devices
- Display of outdoor temperature or time of day via KNX bus
- Time scheduling and central control of setpoints via KNX bus
- With a Synco RMB7xx controller, the energy demand signal of the thermostat is used to optimize energy supply.

RDF301.50 only:

- Four buttons to control KNX actuators via KNX S-mode ("switching groups" with functions such as switching, dimming, blinds control, 8-bit scene)

Applications

The thermostats support the following applications, which can be configured using the DIP-switches on the inner side of the thermostat's front panel or a commissioning tool.

All DIP switches need to be set to OFF (remote configuration, factory setting) to select an application via commissioning tool.

2-pipe fan coil unit
heating or cooling

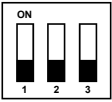
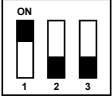
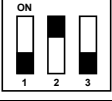
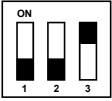
Applications and control outputs	DIP-switches
Remote configuration via commissioning tool (factory setting) <ul style="list-style-type: none"> • Synco ACS • ETS3 professional (planned) 	
2-pipe, on/off 1-stage compressor, on/off	
2-pipe, modulating, 3-position	
2-pipe fan coil unit with electrical heater heating or cooling	2-pipe with electrical heater, on/off 1-stage compressor with electrical heater, on/off
4-pipe fan coil unit heating and cooling	4-pipe on/off Compressor, on/off
	













Type summary

Product number	Stock number	Operating voltage	Control outputs				Housing color
			3 pt	on/off	DC 0..10 V	KNX switching groups	
RDF301	S55770-T104	AC 230 V	✓	✓	--		white
RDF301.50	S55770-T105	AC 230 V	✓	✓	--	✓	white

Ordering

- When ordering, indicate both product number / SSN number and name:
E.g. **RDF301 / S55770-T104 room thermostat**
- Order valve actuators separately.

Equipment combinations

	Type of unit		Product no.	Data sheet
	Cable temperature sensor		QAH11.1	1840
	Room temperature sensor		QAA32	1747
	Condensation detector / Supply unit		QXA2000 / QXA2001 / AQX2000	1542
On / off actuators	Electromotoric on / off valve and actuator (only available in AP, UAE, SA and IN)		MVI.../MXI...	4867
	Electromotoric on / off actuator		SFA21...	4863
	Thermal actuator (for radiator valve)		STA21...	4893
	Thermal actuator (for small valves 2.5 mm)		STP21...	4878
	Zone valve actuators (only available in AP, UAE, SA and IN)		SUA...	4830
3-position actuators	Electrical actuator, 3-position (for radiator valve)		SSA31...	4893
	Electrical actuator, 3-position (for small valve 2,5 mm)		SSP31...	4864
	Electrical actuator, 3-position (for small valve 5,5 mm)		SSB31...	4891
	Electrical actuator, 3-position (for small valve 5,5 mm)		SSD31...	4861
	Electromotoric actuator, 3-position (for valves 5.5 mm)		SQS35...	4573

Type of unit	Product no / SSN	Data sheet
Changeover mounting kit (50 pcs/package)	ARG86.3	N3009
Plastic mounting bracket for semi-flush-mount thermostats for increasing the headroom in the conduit box by 10mm	ARG70.3	N3009
Conduit box for semi-flush mounted thermostat	ARG71 / S55770-T137	N3009
KNX Power supply 160 mA (Siemens BT LV)	5WG1 125-1AB01	--
KNX Power supply 320 mA (Siemens BT LV)	5WG1 125-1AB11	--
KNX Power supply 640 mA (Siemens BT LV)	5WG1 125-1AB21	--

Mechanical design

The thermostats consist of 2 parts:

- Front panel with electronics, operating elements and built-in room temperature sensor.
- Mounting base with power electronics.

The rear of the mounting base contains the screw terminals.

The base fits on a rectangular conduit box with 60.3 mm fixing centers.

Slide the front panel in the mounting base and snap on.

Operation and settings

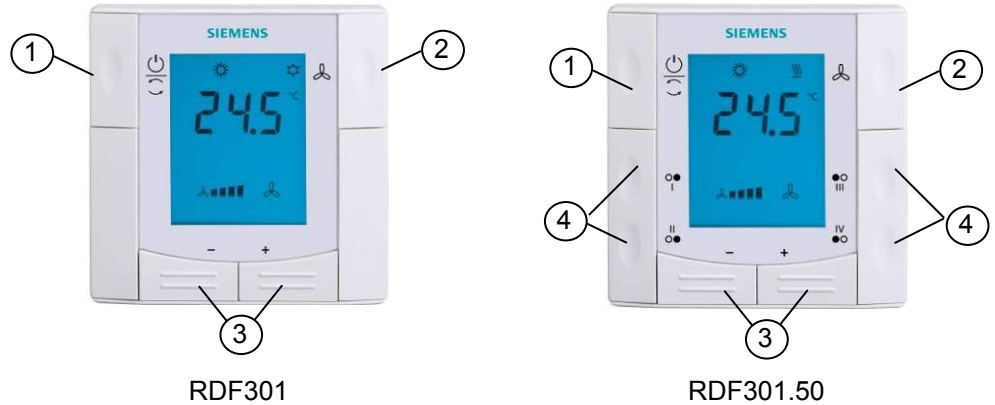

- 1 Operating mode selector
- 2 Change fan operation
- 3 Adjust setpoint and control parameters
- 4 Four buttons to control KNX actuators via KNX S-mode (functions: switching, dimming, blinds control, 8-bit scene)

Display

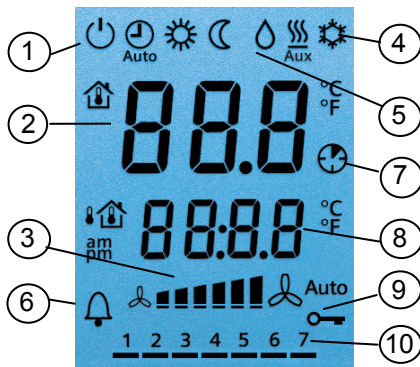

- | | |
|--|---|
| <p>1 Operating mode</p> <ul style="list-style-type: none"> ⏻ Protection ☀️ Comfort 🌙 Economy 🕒 Auto Timer according to schedule (via KNX) <p>2 Displays room temperature, set-points and control parameters.</p> <p>3 Fan mode</p> <ul style="list-style-type: none"> 🌀 Auto Auto fan active 📊 Fan speed low, medium, high <p>4 Heating/cooling mode</p> <ul style="list-style-type: none"> ☀️ Cooling 🔥 Heating 🔥 Aux Electrical heater active | <p>5 💧 Condensation in room (dewpoint sensor active)</p> <p>6 🔔 Indicates fault or reminder</p> <p>7 🏠 Temporary comfort mode extension active</p> <p>8 Additional user information, like outdoor temperature 🏠 or time of day from KNX bus. Selectable via parameters</p> <p>9 🗝️ Button lock active</p> <p>10 <u>1 2 3 4 5 6 7</u>
Weekday 1...7 from KNX bus (1 = Monday / 7 = Sunday)</p> |
|--|---|

Engineering notes

See the "Reference documentation", page 11 for information on how to engineer the KNX bus (topology, bus repeaters, etc.) and how to select and dimension connecting cables for supply voltage and field devices.

Mounting and installation

Mount the room thermostat on a recessed rectangular conduit box with 60.3 mm fixing centers. Do not mount on a wall in niches or bookshelves, behind curtains, above or near heat sources, or exposed to direct solar radiation. Mount about 1.5 m above the floor.

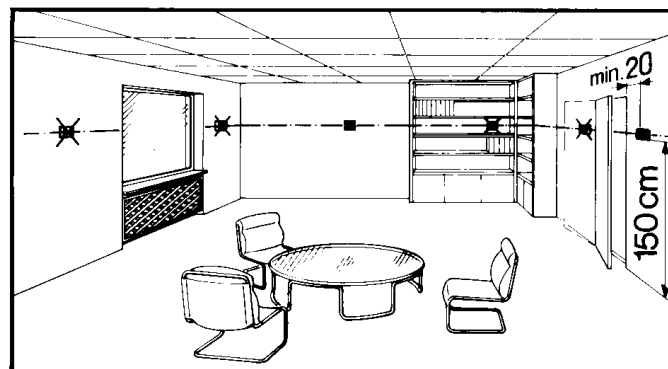

Mounting



- Mount the room thermostat on a clean, dry indoor place without direct airflow from a heating / cooling device, and not exposed to drips or splash water.
- In case of limited space in the conduit box use the mounting bracket ARG70.3 to increase the headroom by 10mm

Wiring



See the mounting instructions M3171 enclosed with the thermostat.

- Comply with local regulations to wire, fuse and earth the thermostat.
- Properly size the cables to the thermostat, fan and valve actuators for AC 230 V mains voltage.
- Use only valve actuators rated for AC 230 V.
- The AC 230 V mains supply line must have an external fuse or circuit breaker with a rated current of no more than 10 A.
- Isolate the cables of SELV inputs X1-M/X2-M for 230 V if the conduit box carries AC 230 V mains voltage.
- Inputs X1-M or X2-M of different units (e.g. summer/winter switch) may be connected in parallel with an external switch. Consider overall maximum contact sensing current for switch rating.
- Isolate the cables of KNX communication input CE+ / CE- for 230 V if the conduit box carries AC 230 V mains voltage.
- No metal conduits.
- No cables provided with a metal sheath.
- Disconnect from supply before opening the cover.

Commissioning notes

Applications

The room thermostats are delivered with a fixed set of applications.

Select and activate the relevant application during commissioning using one of the following tools:

- Local DIP switch and HMI
- Synco ACS
- ETS3 Professional (planned)

Set the DIP switches before snapping the front panel to the mounting plate, if you want to select an application via **DIP switches**.

All DIP switches need to be set to "OFF" ("remote configuration"), if you want to select an application via **commissioning tool**.

After power is applied, the thermostat resets and all LCD segments flash, indicating that the reset was correct. After the reset, which takes about 3 seconds, the thermostat is ready for commissioning by qualified HVAC staff.

If all DIP switches are OFF, the display reads "NONE" to show that an application needs to be set via tool.

Note Each time the application is changed, the thermostat reloads the factory setting for all control parameters, except for KNX device and zone addresses!

Connect tool

Connect the Synco ACS or ETS3 Professional tools to the KNX bus cable at any point for commissioning:

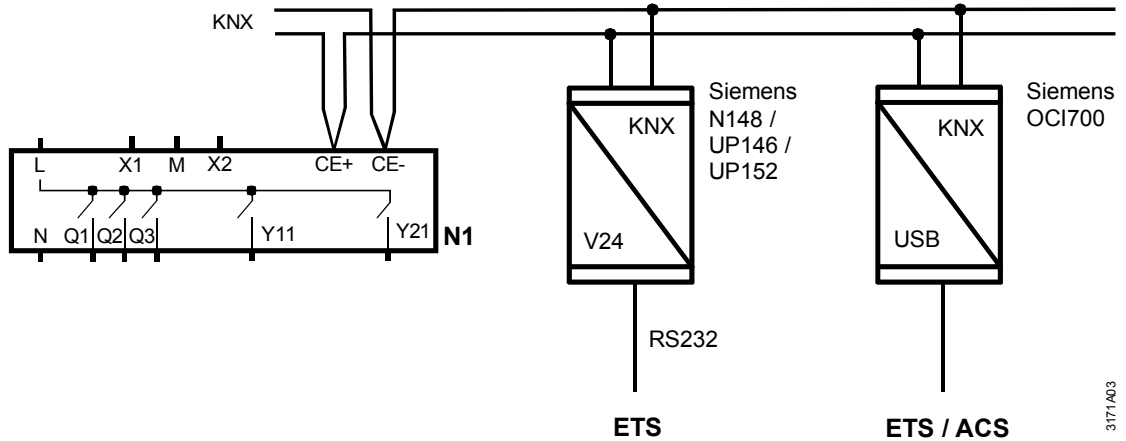

ACS and ETS3 require an interface:

- RS232 KNX interface (e.g. Siemens N148 / UP146 / UP152)
- OC1700 USB- KNX interface

Note An external KNX bus power supply is required if an RDF301.. is connected directly to a tool (ACS or ETS3) via KNX interface.

Control parameters

The thermostat's control parameters can be set to ensure optimum performance of the entire system (see basic documentation P3171). The parameters can be adjusted using

- Local HMI
- Synco ACS
- ETS3 Professional (planned)

Control sequence

- The control sequence may need to be set via parameter P01 depending on the application. The factory setting for the 2-pipe application is "Cooling only"; and "Heating and Cooling" for the 4-pipe application.

Compressor-based application 

- When the thermostat is used with a compressor, adjust the minimum output on-time (parameter P48) and off-time (parameter P49) for Y11/Y21 to avoid damaging the compressor or shortening its life due to frequent switching.

Calibrate sensor

- Recalibrate the temperature sensor if the room temperature displayed on the thermostat does not match the room temperature measured (after min. 1 hour of operation). To do this, change parameter P05.

Setpoint and range limitation

- We recommend to review the setpoints and setpoint ranges (parameters P08...P12) and change them as needed to achieve maximum comfort and save energy.

Programming mode

The programming mode helps identify the thermostat in the KNX network during commissioning.

Press buttons "operating mode"  and "+" simultaneously for 6 sec to activate programming mode, which is indicated on the display with "PrO9". Programming mode remains active until thermostat identification is complete.

Assign KNX group addresses

Use ETS3 Professional to assign the KNX group addresses of the RDF communication objects.

Switching groups

RDF301.50 only

RDF301.50 has 2 switching groups with a pair of buttons each, which must be configured via ETS3. The switching groups only work on S-mode.

KNX serial number

Each device has a unique KNX serial number inside the front panel. An additional sticker with the same KNX serial number is enclosed in the packaging box. This sticker is intended for installers for documentation purposes.



Disposal



This device is classified as waste electronic equipment under European Directive 2002/96/EC (WEEE) and may not be disposed of as unsorted municipal waste. Adhere to all relevant national laws. Regarding disposal, use the systems setup for collecting electronic waste. Observe all local and applicable laws.

Technical data

⚠ Power supply	Operating voltage	AC 230 V +10/-15 %
	Rated voltage	AC 230 V
	Frequency	50/60 Hz
	Power consumption	max. 4VA / 3.4W
Outputs	Fan control Q1, Q2, Q3-N	AC 230 V
	Rating	Max. 5(2) A
	Control output Y11-N / Y21-N (N.O.)	AC 230 V
Inputs	Rating	Max. 5(2) A
	Multifunctional input X1-M/X2-M	
	Temperature sensor input:	
	Type	QAH11.1 (NTC)
	Digital input:	
	Operating action	Selectable (NO / NC)
	Contact sensing	SELV DC 0...5 V/max 5 mA
	Insulation against mains voltage (SELV)	4 kV, reinforced insulation
	Function of inputs:	Selectable
	External temperature sensor, heating/cooling changeover sensor, operating mode switchover contact, dewpoint monitor contact, enable electrical heater contact, fault contact, monitoring input	X1: P38 X2: P40
KNX bus	Interface type	KNX, TP1-64 (electrically isolated)
	Bus current	20 mA
	Bus topology:	See KNX manual (reference documentation, see below)
Operational data	Switching differential, adjustable	
	Heating mode (P30)	2 K (0.5...6K)
	Cooling mode (P31)	1 K (0.5...6K)
	Setpoint setting and range	
	☀ Comfort (P08)	21°C (5...40 °C)
	☾ Economy (P11-P12)	15°C/30°C (OFF, 5...40 °C)
🔌 Protection (P65-P66)	8°C/OFF (OFF, 5...40 °C)	

	Multifunctional input X1/X2	Selectable 0...8
	Input X1 default value	(P38) 3 (Operating mode switchover)
	Input X2 default value	(P40) 1 (External temperature sensor)
	Built-in room temperature sensor	
	Measuring range	0...49 °C
	Accuracy at 25 °C	< ± 0.5 K
	Temperature calibration range	± 3.0 K
	Settings and display resolution	
	Setpoints	0.5 °C
	Current temperature value displayed	0.5 °C
Environmental conditions	Operation	As per IEC 721-3-3
	Climatic conditions	Class 3K5
	Temperature	0...50 °C
	Humidity	<95 % r.h.
	Transport	As per IEC 721-3-2
	Climatic conditions	Class 2K3
	Temperature	-25...60 °C
	Humidity	<95 % r.h.
	Mechanical conditions	Class 2M2
	Storage	As per IEC 721-3-1
	Climatic conditions	Class 1K3
	Temperature	-25...60 °C
	Humidity	<95 % r.h.
Standards and directives	 conformity	
	EMC directive	2004/108/EC
	Low-voltage directive	2006/95/EC
	 C-tick conformity to EMC emission standard	AS/NZS 61000.6.3: 2007
	 Reduction of hazardous substances	2002/95/EC
	Product standards	
	Automatic electrical controls for household and similar use	EN 60730-1
	Special requirements for temperature-dependent controls	EN 60730-2-9
	Electronic control type	2.B (micro-disconnection on operation)
	Home and Building Electronic Systems	EN 50090-2-2
Electromagnetic compatibility		
Emissions (residential)	IEC/EN 61000-6-3	
Immunity (industrial and residential)	IEC/EN 61000-6-2	
Safety class	II as per EN 60730	
Pollution class	Normal	
Degree of protection of housing	IP 30 as per EN 60529	
General	Connection terminals	Solid wires or prepared stranded wires 1 x 0.4...2.5 mm ² or 2 x 0.4...1.5 mm ²
	Housing front color	RAL 9003 white
	Weight without / with packaging	0.246 kg / 0.316 kg

Reference documentation	Handbook for Home and Building Control - Basic Principles (www.knx.org/uk/news-press/publications/publications/)
Synco	CE1P3127 Communication via the KNX bus for Synco 700, 900 and RXB/RXL Basic documentation
DESIGO	CM1Y9775 DESIGO RXB integration – S-mode CM1Y9776 DESIGO RXB / RXL integration – individual addressing CM1Y9777 Third-party integration CM1Y9778 Synco integration CM1Y9779 Working with ETS
Apogee	Installation Instruction: KNX Driver for PXC Modular; Document No. 565-132 Technical Spec Sheet: KNX Driver for PXC Modular; Document No. 127-1676 Technical Reference for KNX Driver; Document No. 140-0804 Application 6205 Point Map for RDF

Connection terminals

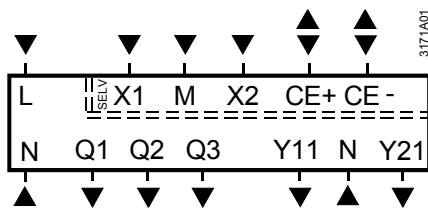

L, N	Operating voltage AC 230 V
Q1	Control output "Fan speed 1 AC 230 V"
Q2	Control output "Fan speed 2 AC 230 V"
Q3	Control output "Fan speed 3 AC 230 V"
Y11, Y21	Control output "Valve" AC 230 V (N.O., for normally closed valves), output for compressor or output for electrical heater
X1, X2	Multifunctional input for temperature sensor (e.g. QAH11.1) or potential-free switch Factory setting: – X1 = Operating mode switchover contact – X2 = External sensor (function can be selected via parameter P38 / P40).
M	Measuring neutral for sensor and switch
CE+	KNX data +
CE-	KNX data -

Connection diagrams

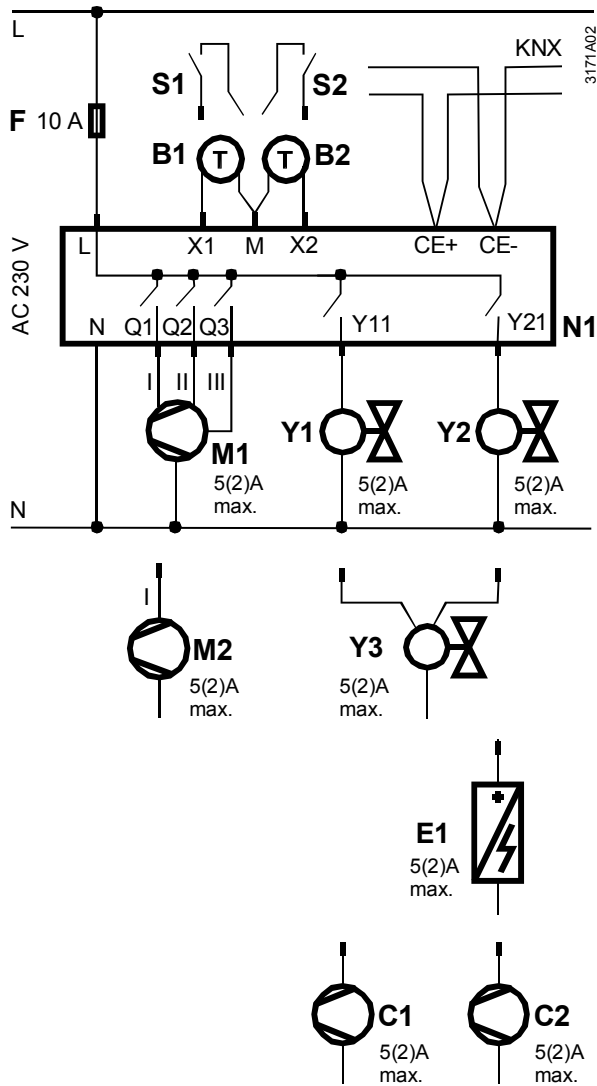

- N1 Room thermostat RDF301...
- M1 3-speed fan
- M2 1-speed fan
- Y1, Y2 Valve actuator
- E1 Electrical heater
- F External fuse
- S1, S2 Switch (keycard, window contact, etc.)
- B1, B2 Temperature sensor (return air temperature, external room temperature, changeover sensor, etc.)
- CE+ KNX data +
- CE- KNX data -

Dimensions

Dimensions in mm

